

Power Purchase Agreements for Grid-Aware Renewable Energy Procurement

Agenda and learning objectives

- **Part 1: Introduction to Power Purchase Agreements (PPAs) for Renewable Energy (RE) Procurement**
 - Define PPAs and their importance to reducing RE procurement risk.
- **Part 2: Flexibility and Reliability Considerations in PPAs**
 - Identify considerations that can be incorporated into PPAs for variable RE generators that enhance the flexibility and reliability of the power system.
- **Part 3: Xcel Energy's Model PPA for Wind Energy**
 - Become familiar with how a vertically-integrated utility in the U.S. is using PPAs to support the integration of wind to its system.

Key takeaways

Well-designed PPAs can contribute to cost effective integration of variable RE to the power system.

- As the penetration of variable RE on the grid increases, non-synchronous generation will replace the synchronous generation that has traditionally provided a variety of grid support services.
- Modern utility-scale solar and wind generators are capable of providing grid services... However, institutional measures need to be in place (preferably from the inception of the project) to ensure these capabilities are present and accessible to the system operator.
- PPAs can augment other mechanisms such as grid codes to require or incentivize variable RE generators to support reliable, flexible power system operation.
- No “one size fits all” approach: PPA provisions are system dependent.

A few definitions

- **Variable renewable energy (VRE):** Electricity generation technologies whose primary energy source varies over time and cannot easily be stored. In this presentation, usually refers to solar photovoltaic (PV) and wind energy technologies.
- **Independent power producer (IPP):** a non-utility entity that owns facilities that generate electricity for sale to utilities or other end users.
- **Flexibility:** The ability of a power system to respond to changes in electricity demand and supply.
- **Curtailement:** The practice of temporarily decreasing electricity supply from a generator below what it could potentially produce from available resources.
- **Ancillary services:** Functions that help power system operators maintain a reliable electricity system.
- **Grid code or interconnection standard:** a technical specification which defines the requirements that a facility connected to the public electricity network must meet to ensure safe, reliable, and economic system operations.



INTRODUCTION TO PPAS FOR RE PROCUREMENT

What is a PPA?

- PPAs are one of the key mechanisms that utilities use to procure variable RE from IPPs.
 - Legally binding, long-term (20-25 years) contract
 - Sets the price of electricity
 - Includes legal obligations of all parties
- PPAs help to overcome some of the major barriers associated with RE procurement.
 - Price for electricity is not dependent on market forces or fuel prices
 - Helps to secure project financing for RE developers

Allocation of risks in PPA design

- Dispatch
 - Take or pay (guaranteed revenue for seller; take delivery or pay a penalty)
 - Take and pay (contingent upon delivery; curtailed energy not necessarily compensated)
- Cost
 - Energy tariff per kilowatt-hour, must cover debt and provide return
 - Price may be fixed, inflated, or indexed to indicator
- Transmission or interconnection
 - Indicate which party is responsible
 - Identify the point of interconnection (POI)



**FLEXIBILITY AND
RELIABILITY
CONSIDERATIONS FOR
PPAS**

VRE can provide grid services

- Grid services refer to ancillary functions that support system requirements for reliability and stability of the grid
 - Provide support for **balancing under normal operations** or for **recovery following a grid disturbance** such as an outage
 - Examples of services: spinning reserves, load following, ramping, frequency response, variability smoothing, frequency regulation, and power quality

Modern solar and wind energy technologies can increase the responsiveness and flexibility of the power system by providing grid services...

But only if the policy, regulatory, and market frameworks support their participation.

PPAs provide a mechanism for VRE to contribute grid services

- Traditional thermal units provide grid services in many cases for free in vertically integrated utility structure.
- With higher penetrations of VRE, a system's synchronous generation will be replaced by non-synchronous (inverter-connected) generation.
- Institutional measures such as grid codes or interconnection agreements can require VRE generators to provide grid services.
- A PPA may include operational requirements beyond grid code (*or maybe no grid code exists*), and/or incentives to compensate ancillary services/grid support functions.

Background: generator contribution to system frequency

Frequency

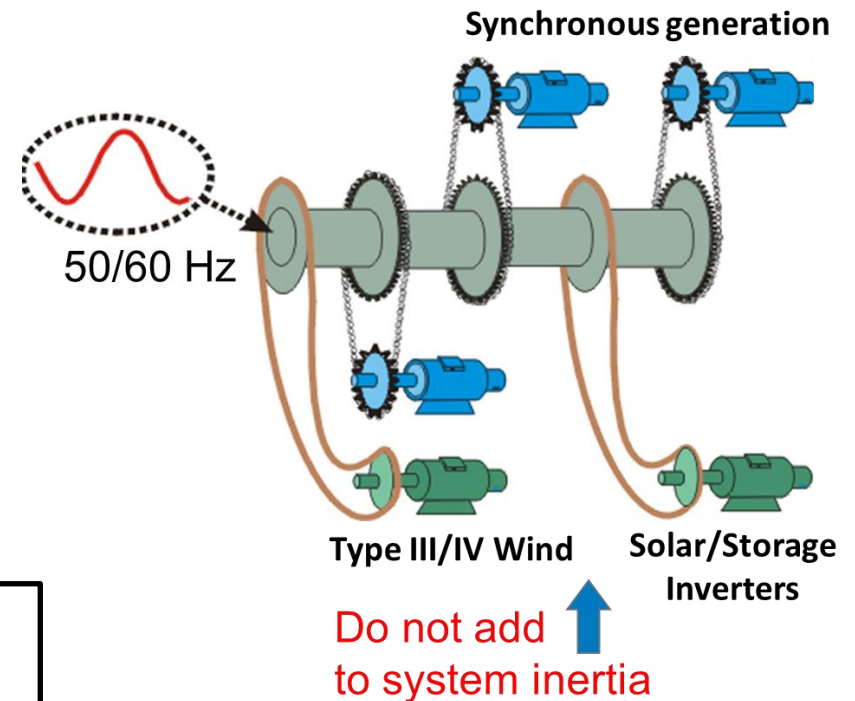
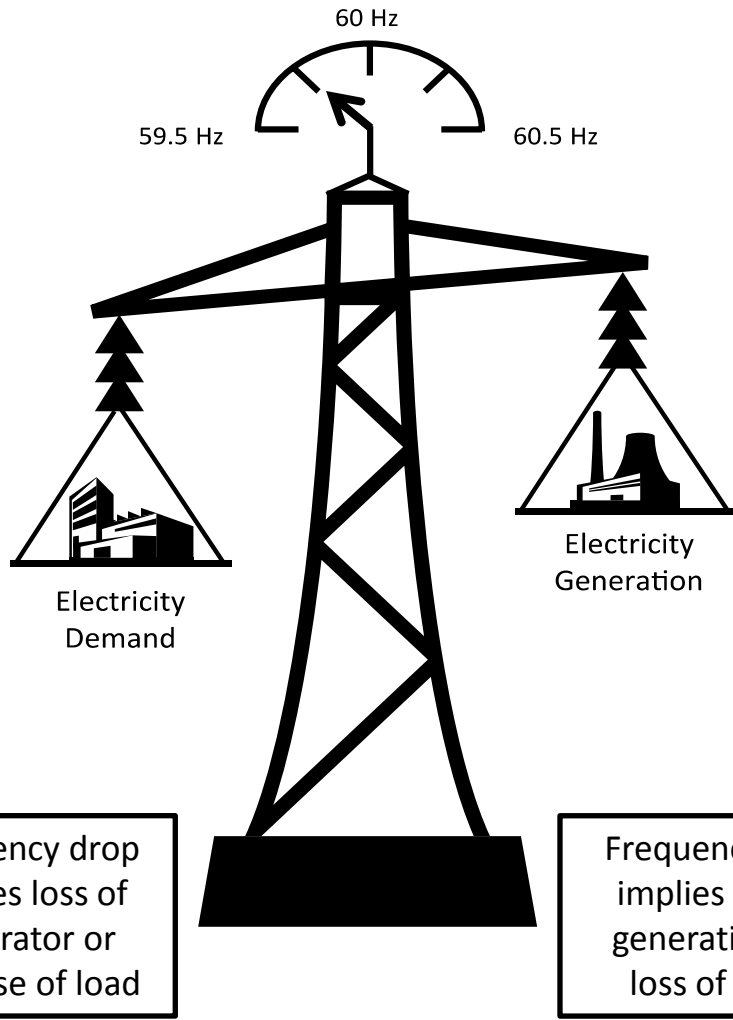

PPA considerations: Incorporate frequency range requirements

- Example provision:
 - Lower and upper bound for operational frequency of an VRE generator
- Why is this important?
 - Ensures VRE generators stay connected during deadband and can change power output when outside of it
 - Allows VRE generators to support recovery and avoid worsening the problem

ΔP = change in power

Δf = change in frequency

Deadband: range of frequency in which no change in power output must occur

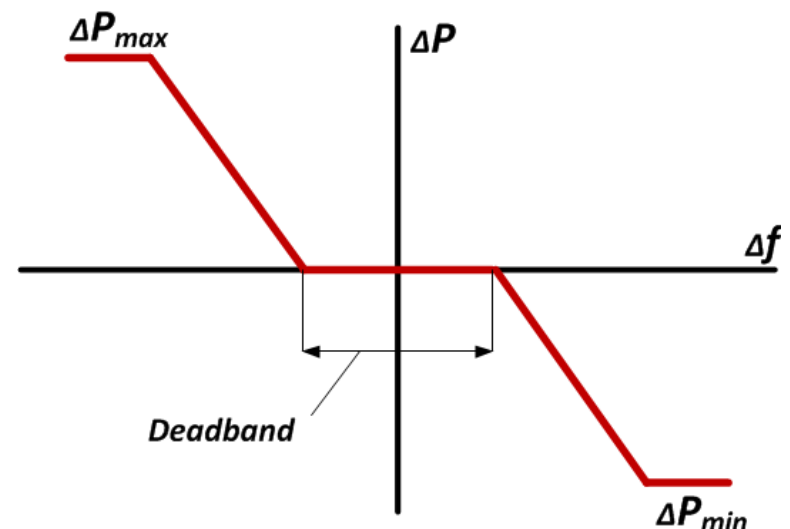

PPA considerations: Incorporate voltage limit requirements

- Example provision:
 - Acceptable operational voltage fluctuation of the VRE generator, often expressed as percentage, e.g., +/-2%, of nominal voltage level
- Why is this important?
 - Minimizes impacts of voltage fluctuations, which can damage the utility's electromechanical equipment if outside certain limits

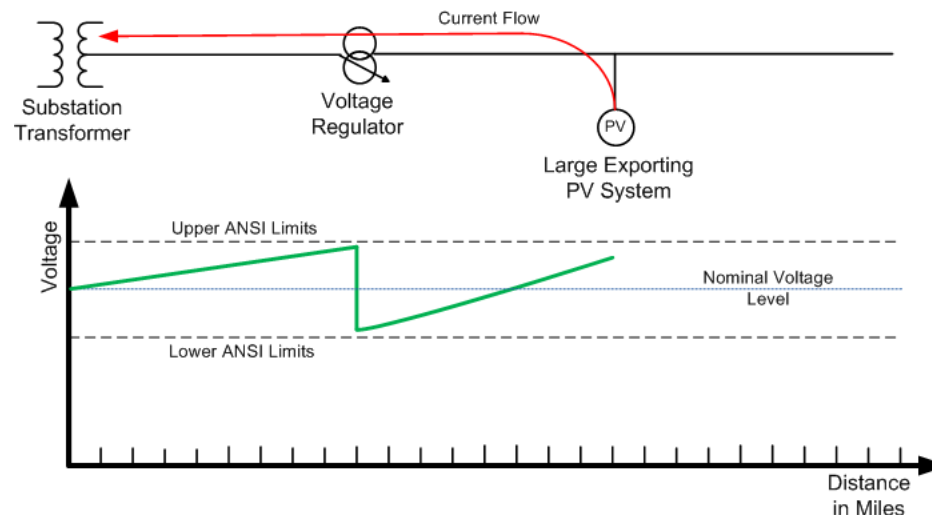

ANSI = American National Standards Institute

PPA considerations: Specify voltage mode(s)

- Example provision:
 - Preferred mode(s) of operation for VRE generators. Modes include unity power factor, reactive power, or voltage control
- Why is this important?
 - Impacts the VRE generator's contribution to overall power system efficiency
 - System operators can choose a facility's mode based on local grid needs

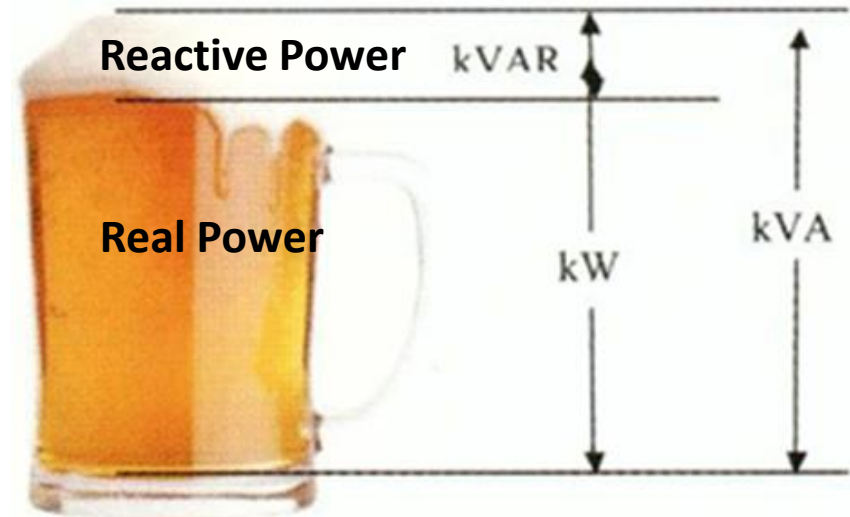

$$\text{Power}_{\text{DC}} = I (\text{current}) * V (\text{voltage})$$

Power factor = Ratio of real power to apparent power = phase angle between voltage and current

Power_{AC} = vectoral sum of Real Power + Reactive Power

PPA considerations: Require voltage ride-through (VRT)

Example provision:

- Requirement for VRE to stay online during system voltage disturbances
- ZVRT (zero), LVRT (low), HVRT (high) requirements are duration dependent

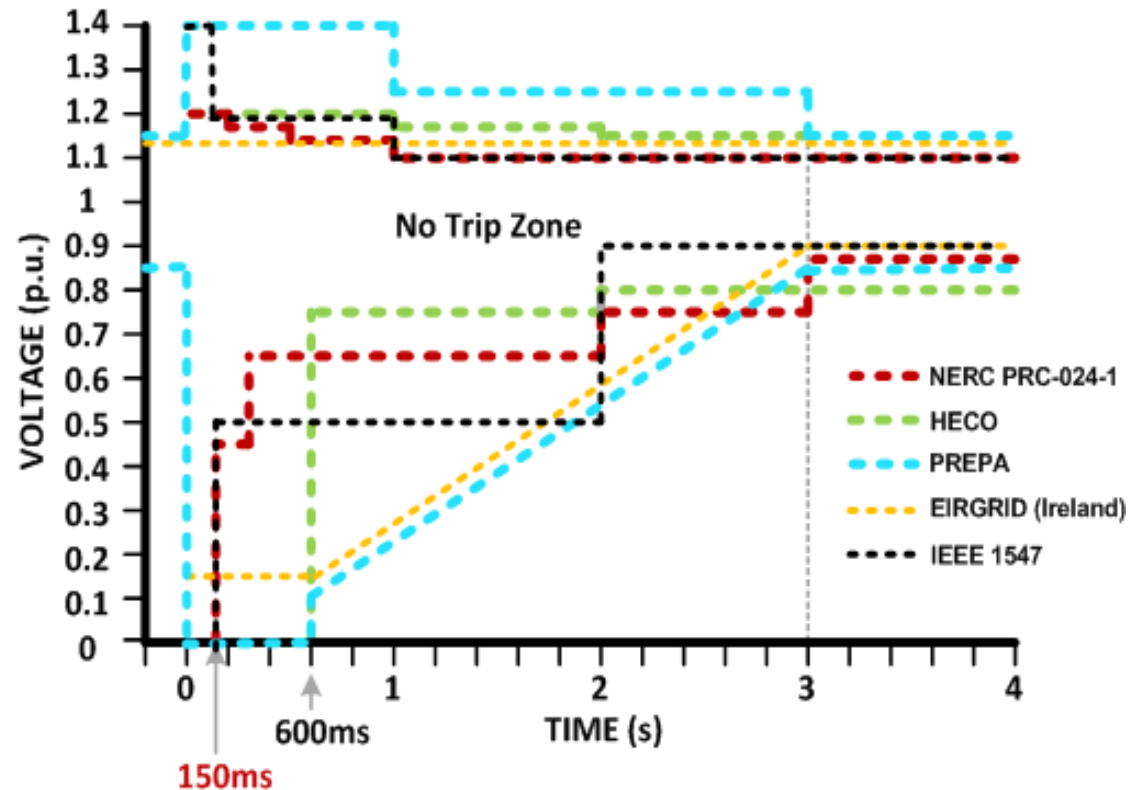

Why is this important?

Can prevent cascading failure of electricity supply during severe under- or over-voltage periods

Source: Vahan Gevorgian, NREL

PPA considerations: Incorporate advanced Supervisory Control And Data Acquisition

Example provision:

- Require monitoring and control capabilities that enable the system operator to monitor VRE plant performance in near real-time

Why is this important?

- Improves system operator awareness and ability to respond to system conditions (e.g., optimally dispatch reserves, issue curtailment orders)
- Necessary to fully utilize grid services available from VRE

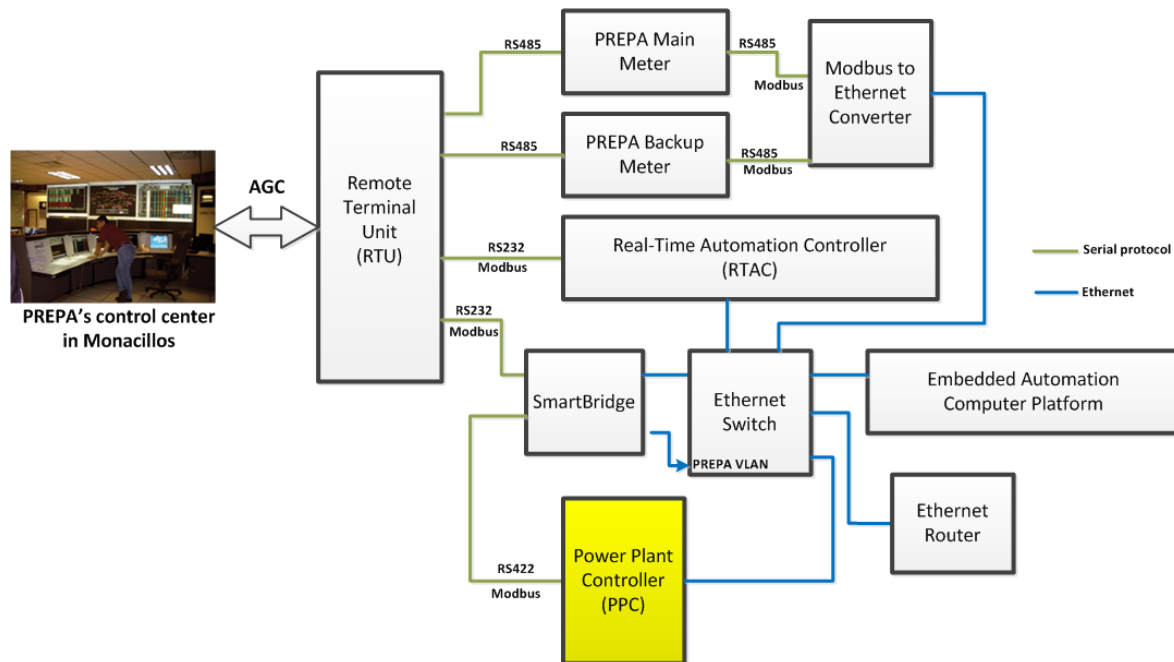

Source: V. Gevorgian, B. O'Neill, "Advanced Grid-Friendly Controls Demonstration Project for Utility-Scale PV Power Plants." NREL/TP - 5D00-65368, January 2016

PPA considerations: Facilitate VRE Forecasting

Example provisions:

- Centralized forecasts: require VRE generators to provide data to facilitate forecasting by the operator
- Decentralized forecasts: require VRE generators to provide generation forecasts (e.g., day-ahead)

Why is this important?

- VRE forecasting important for minimizing operating reserves and understanding availability of VRE to provide ancillary services

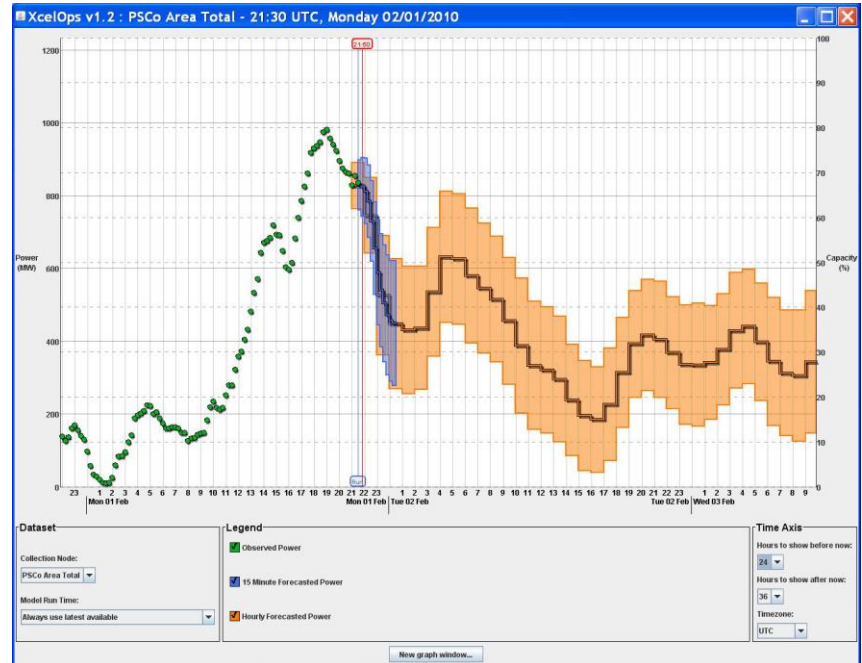

Source: [NCAR 2015](#)

Example data requirements for centralized forecasting:

- **Basic:** Generator location, installed capacity, historic hourly generation, detailed meteorological data (e.g., wind speed, air density, humidity, irradiance, temperature)
- **Advanced:** Real-time generation, wind turbine or solar array availability

PPA considerations: Facilitate additional ancillary services provision

- Example provisions—VRE contributes to:
 - Frequency response
 - Inertial (sub-seconds to seconds, e.g., 0-5s)
 - Primary (seconds, e.g., 5-30s)
 - Secondary frequency response, automatic generator control (AGC), regulation (minutes, e.g., 30s-10m)
 - Voltage stability
 - Reserves
 - Spinning, dynamic
 - Contingency (respond to an unexpected outage)
 - Black start capability
- Why is this important?
 - Encourages VRE to provide ancillary services in jurisdictions where market or other institutional incentives are not adequate

Which technologies can provide which ancillary services?

Ancillary Services

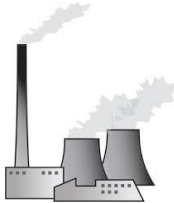
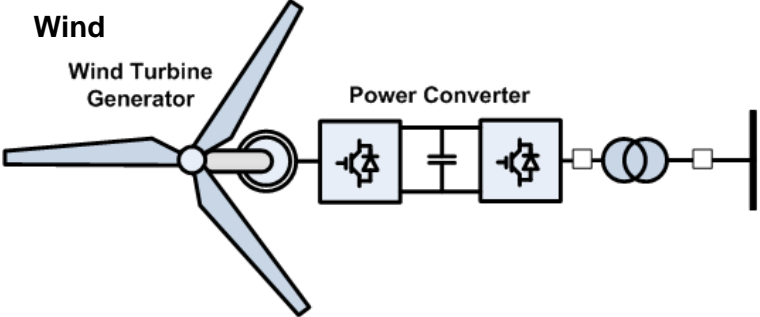
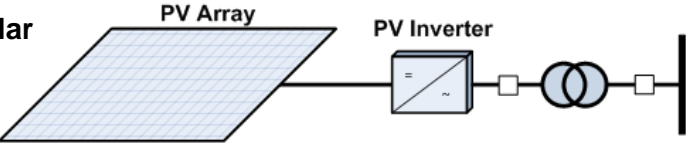
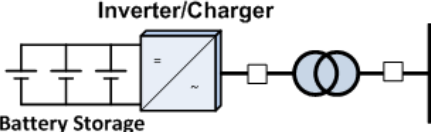
Generation Technology	Mechanical Inertia	Active power control	Reactive power, voltage control
<p>Conventional</p> 	<input checked="" type="checkbox"/>	<input checked="" type="checkbox"/>	<input checked="" type="checkbox"/>
<p>Wind</p> 	<input checked="" type="checkbox"/>	<input checked="" type="checkbox"/>	<input checked="" type="checkbox"/>
<p>Solar</p> 	<input type="checkbox"/>	<input checked="" type="checkbox"/>	<input checked="" type="checkbox"/>
<p>Battery</p> 	<input type="checkbox"/>	<input checked="" type="checkbox"/>	<input checked="" type="checkbox"/>

PPA considerations: Encourage the provision of automatic generation control (AGC)

- Example provision:
 - Require or incentivize VRE generators to implement AGC, which allows the operator to remotely and automatically adjust the output from a generator, based on system load and frequency
- Why is this important?
 - Enables VRE to participate in load following/secondary frequency response

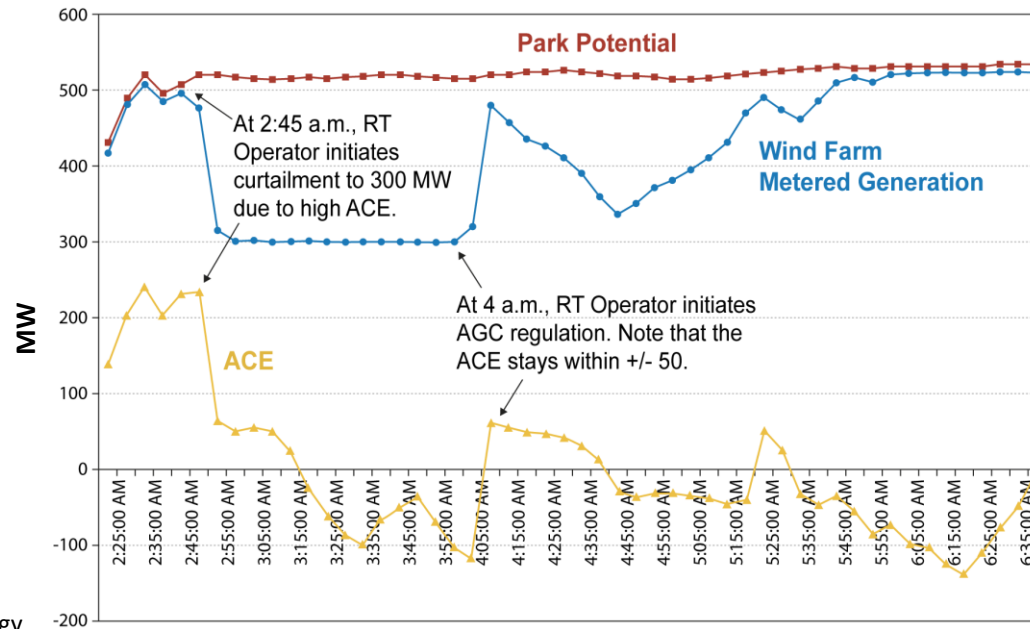

Area Control Error (ACE) is difference between scheduled and actual area interchange

Key takeaways

Well-designed PPAs can contribute to cost effective integration of variable RE to the power system.

- As the penetration of VRE on the grid increases, non-synchronous generation will replace the synchronous generation that has traditionally provided a variety of grid support services.
- Modern utility-scale solar and wind generators are capable of providing grid services... However, institutional measures need to be in place (preferably from the inception of the project) to ensure these capabilities are present and accessible to the system operator.
- PPAs can augment other mechanisms such as grid codes to require or incentivize variable RE generators to support reliable, flexible power system operation.
- No “one size fits all” approach: PPA provisions are system dependent.

Power Purchase Agreements

XCEL ENERGY'S MODEL PPA FOR WIND ENERGY

A Diverse Energy Mix for a Sustainable Energy Future

Projected 30% reduction in carbon dioxide emissions by 2020

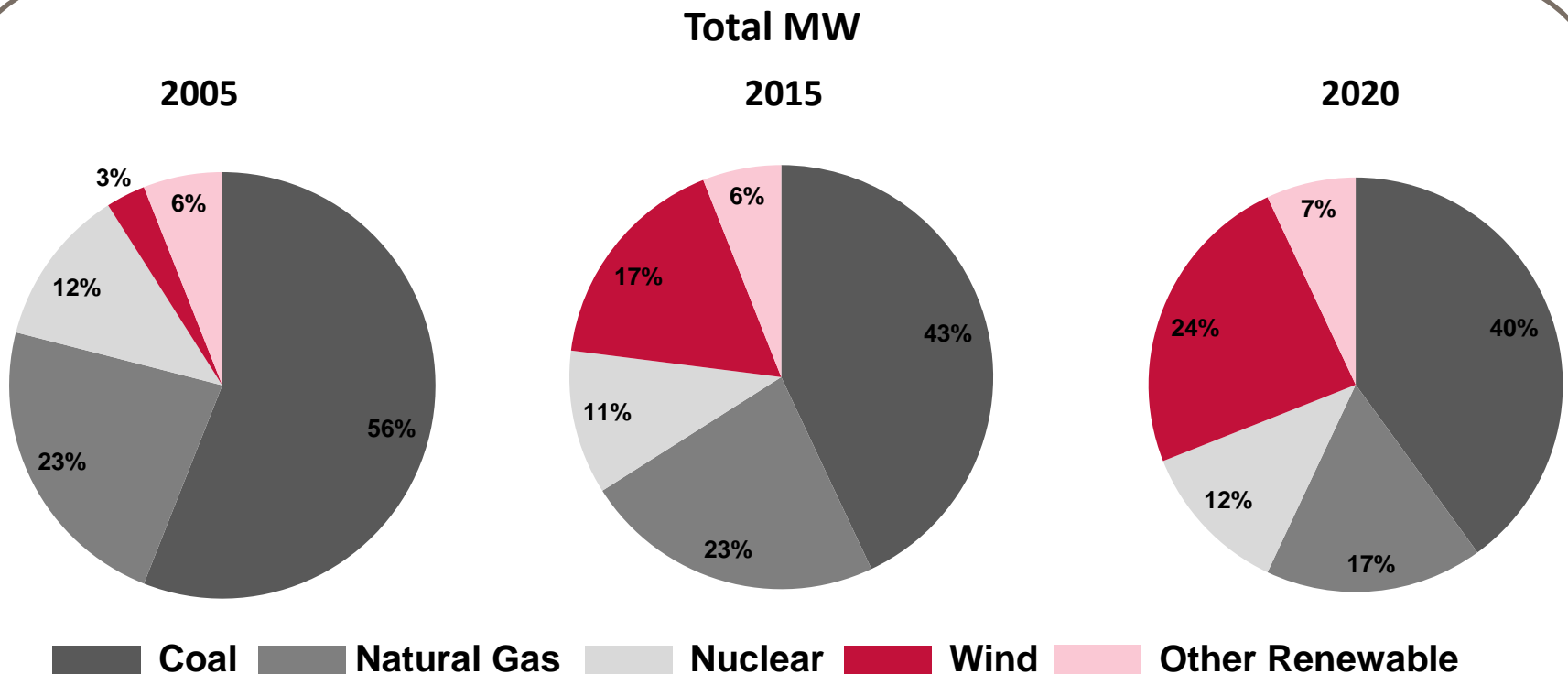

Xcel Energy Wind System Records

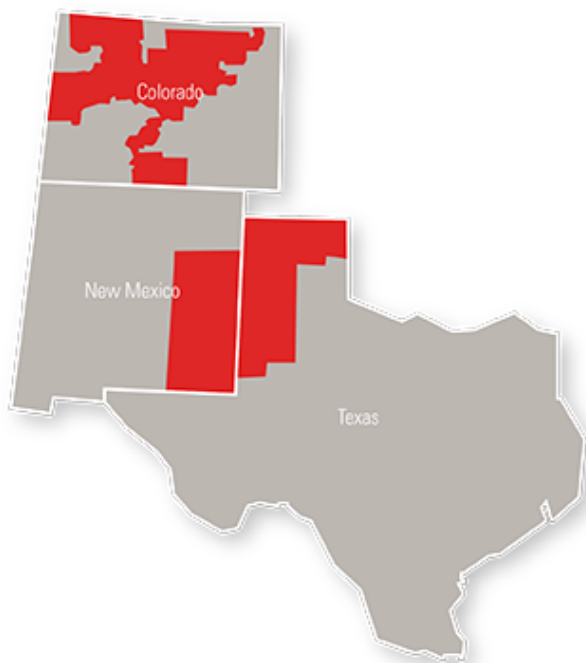
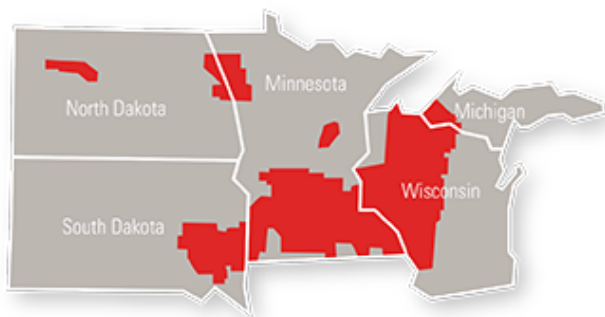

Service Territory:	NSP	PSCo	SPS	XCEL
Name Plate Capacity (MW)	2,617	2,567	1,506	6,690
Max Hourly Generation (MW)	2,366	2,395	1,441	5,481
Date/Time Occurred	12/23/16 12:00 AM	9/1/16 8:00 PM	12/22/15 9:00 PM	12/5/16 8:00 PM
Max Hourly % Load	61.1%	67.6%	57.6%	55.6%
Date/Time Occurred	10/15/16 3:00 AM	4/6/16 1:00 AM	4/5/16 5:00 AM	4/16/16 2:00 AM
Max Daily % Load	48.5%	55.5%	50.83%	45.3%
Date/Time Occurred	Nov 12, 2016	Oct 2, 2015	Nov 15, 2015	Apr 15, 2016

Renewable Procurement Process

- Primary Resource Plan components:
 - Current power supply mix
 - Sales and demand forecast
 - Projection of resource needs
 - Proposed generation technologies to add
 - Competitive procurement process or self-build

Renewable Procurement Process

Two Phase or Track Process

- Phase I
 - Operating Company Resource Plan + testimony
 - Litigated process: Interveners file testimony, OpCo files rebuttal, Public Utilities Commission hearing(s), Commission issues initial decision
- Phase II
 - Competitive bidding process
 - 120-day bid evaluation period
 - Final bid evaluation report and selections
 - Commission issues final decision
 - Company implements approved plan

Model PPA

*Model Wind PPA
February 2013*

WIND ENERGY PURCHASE AGREEMENT

BETWEEN

**NORTHERN STATES POWER COMPANY, A MINNESOTA
CORPORATION**

("COMPANY")

AND

[_____]

("SELLER")

 **Xcel Energy**

- [date] -

[http://www.xcelenergy.com/staticfiles/xcel/Corporate/Corporate%20PDFs/Model Power Purchase Agreement.pdf](http://www.xcelenergy.com/staticfiles/xcel/Corporate/Corporate%20PDFs/Model%20Power%20Purchase%20Agreement.pdf)

Conditions Precedent & Commercial Operations Milestones

Once a PPA has been negotiated and executed, each party will be required to fulfill the Conditions Precedents (CPs) Commercial Operations Milestones outlined in the PPA. These requirements impact both the procurement and development timelines. Examples include:

- Buyer
 - Must seek State Regulatory Approval within “x” amount of days
 - If State Regulatory Approval is rejected, Buyer must terminate within “x” amount of days
- Seller
 - Seller shall achieve closing on financing for the Facility with proof of financial capability to construct the Facility by “x” date
 - The turbine(s)/generator(s)/step-up transformer shall have been delivered to, and installed at, the site by “x” date
 - Seller must achieve Commercial Operation by “x” date

(Article 6 and Exhibit B)

Take or Pay Option

“Beginning on the Commercial Operation Date, Seller shall generate from the Facility, deliver to the Point of Delivery, and sell to Company, and Company shall receive and purchase at the Point of Delivery, the products and services required by this PPA. Seller shall not curtail or interrupt deliveries from the Facility as required by this PPA for economic reasons of any type whatsoever.”

(Article 7 – Sale and Purchase)

Compensable and Non-compensable Curtailments

- Non-compensable Curtailment
 - An emergency
 - Any action taken under the Interconnection Agreement
 - Restriction or reduction of transmission service
 - Seller's failure to maintain full force and effect any permit to construct and/or operate the Facility
 - Seller's failure to maintain Automated Generation Control capability
- Compensable Curtailment
 - Essentially any other type of curtailment not listed as non-compensable

(Article 8 – Payment Calculations)

Allocation of Risks

BUYER

- Market Risks
 - Wholesale Price Risk (wholesale prices are lower than PPA price)
 - Forecast Risk (penalties/costs associated with uncertainty)
 - Congestion Risk (cost associated with transmission congestion)
- Reliability Risk (costs/expense associated with variability - reserves)
- Regulatory Risk (cost of rule changes)

SELLER

- Performance Risk
 - Equipment Risk (turbine failure or underperformance)
 - Construction Risk (penalties associated with missing deadlines)
- Delivery Risk (transmission outages)
- Meteorological Risk (low wind year, cloud cover)

Security & Insurance

- The Seller is required to maintain a Security Fund that is available to pay any amount due to Buyer pursuant to the PPA
 - Buyer is able to draw on the Security Fund for damages due to Buyer for any amounts for which Buyer is entitled to indemnification under the PPA
 - Examples of damages would include not meeting construction milestones or not generating the amount of energy committed per the terms of the PPA

(Article 11 – Security for Performance)
- Seller shall provide Company evidence of insurance coverage for the Facility in compliance with the specifications for insurance coverage set forth in the PPA
 - Buyer shall be named as an additional insured
 - Types of coverage required may include Commercial General Liability, Commercial Umbrella, Worker’s Compensation

(Article 16 – Insurance)

[http://www.xcelenergy.com/staticfiles/xcel/Corporate/Corporate%20PDFs/Model Power Purchase Agreement.pdf](http://www.xcelenergy.com/staticfiles/xcel/Corporate/Corporate%20PDFs/Model%20Power%20Purchase%20Agreement.pdf)

Committed Energy Production

As part of the competitive solicitation process, Seller's must include a committed energy production schedule with their bid. That committed energy schedule becomes a term of the PPA.

- Typically the seller will not be paid in full for excess energy that exceeds 115% of the committed energy in any commercial operation year
- Typically the seller is required to generate at least 85% of the committed energy any commercial operation year or they will be subject to liquidated damages
 - Carve outs can be negotiated such as a “low wind” year

(Article 7 – Sale and Purchase)

AGC, Data Collection & Forecasting

- Automatic Generation Control (AGC)
 - Equipment and capability of the Facility to automatically adjust the generation quantity for the purpose of interchange balancing and automatically adjusting and regulating the Facility's energy production
 - The power grid requires that generation and load closely balance moment by moment and frequent adjustments to generation output is necessary
 - By requiring AGC in the PPA, the Buyer will have the ability to adjust the Seller's output as needed to create this balance across their generation fleet
- Data Collection
 - Meteorological Data
 - Real-Time Park Potential
- Forecasted Turbine Availability
 - Must be posted in a timely manner for the next day's market
 - Any change greater than 10% shall be communicated

(Exhibit H – Data Collection)

Key takeaways

- Renewable Procurement for an Investor Owned Utility (IOU) is a regulated process
- Buyers must guarantee income so that the seller can get financing - that's how deals get done!
- The purpose of negotiating and executing a PPA is to address who takes what risk

Contacts and Additional Information

Webinar Panel

Barbara O'Neill
National Renewable Energy
Laboratory
Email: Barbara.ONeill@nrel.gov

Tara Fowler
Xcel Energy
Email:
tara.fowler@xcelenergy.com

Ilya Chernyakhovskiy
National Renewable Energy
Laboratory
Email:
Ilya.Chernyakhovskiy@nrel.gov

Additional Resources

Greening the Grid

*Resources and Technical
Assistance*

www.greeningthegrid.org

[Fact sheet on grid-aware PPAs](#)

Email: greeningthegrid@nrel.gov

Power Africa Program

Resources and Technical Assistance, e.g.,

[Expanding the Understanding of Power
Purchase Agreements Handbook](#)

Download Xcel Energy's Model Wind PPA:

http://www.xcelenergy.com/staticfiles/xcel/Corporate/Corporate%20PDFs/Model_Power_Purchase_Agreement.pdf